

version .0

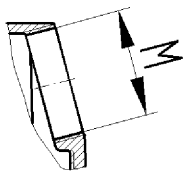

version .1

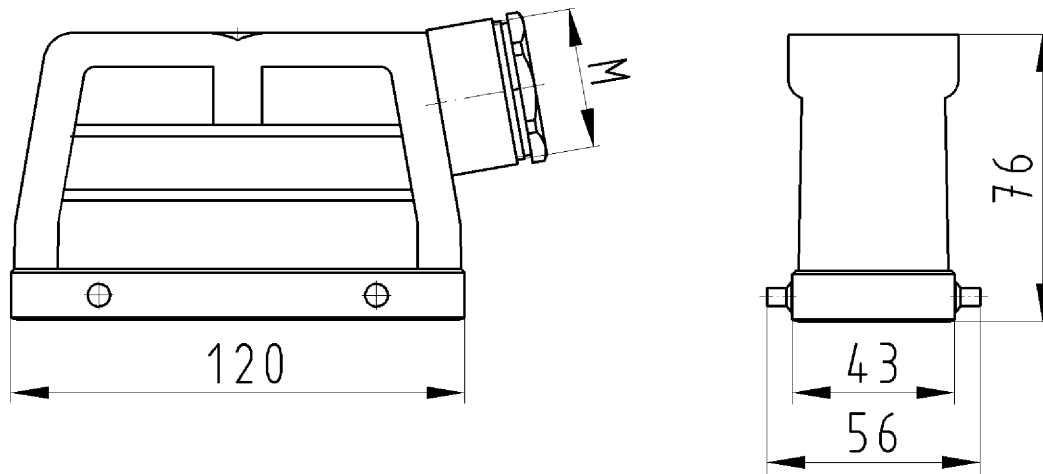
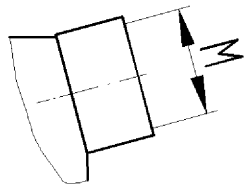

version .2

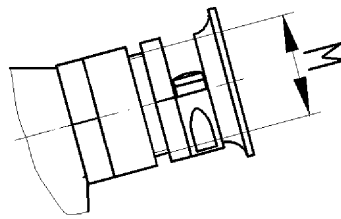

version .3

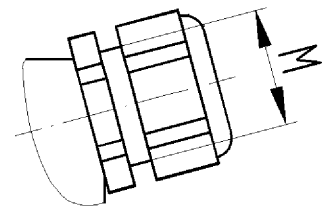

version .5

IP 65

Gehäuseoberteil  
73.350/353.6435.0

Zeichnungsnummer  
73.350.6435.010W  
Gehäuseoberteil

17.12.2007  
Hoffmann Angelika  
M 1:2